

PG3500Ci

Sturm!
нас рекомендуют друзья

Sturm!
нас рекомендуют друзья

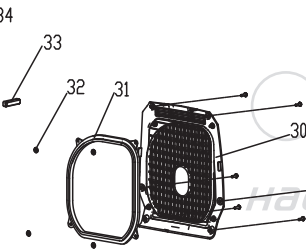
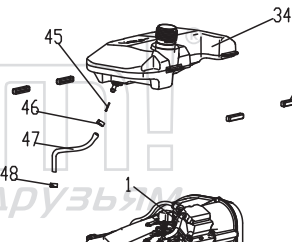
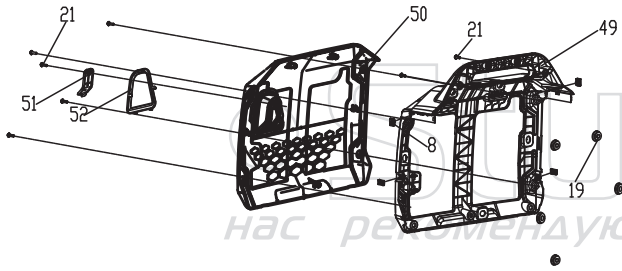
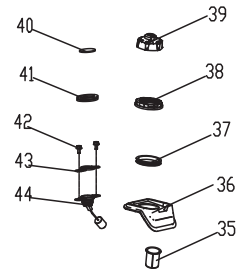

Sturm!
нас рекомендуют друзья

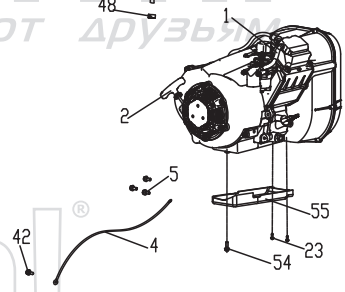
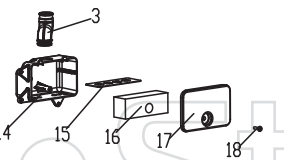
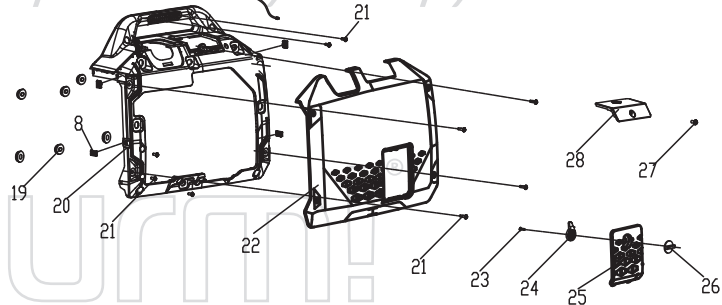

Sturm!
нас рекомендуют друзья

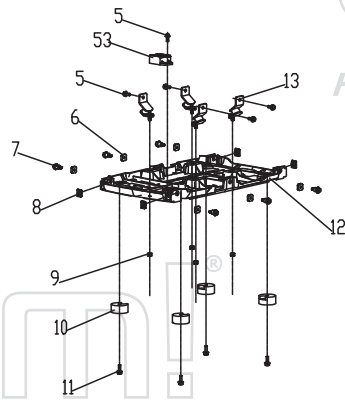

Sturm!
нас рекомендуют друзья

Sturm!
нас рекомендуют друзья

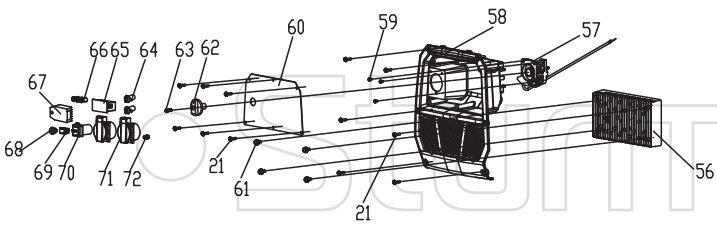

Sturm!
нас рекомендуют друзья

PG3500Ci

NO.	DESCRIPTION	SPEC.	NO.	DESCRIPTION	SPEC.
1	engine		37	Damping and buffering rubber	
2	Starting handle		38	Cover plate	
3	Air filter connection pipe		39	Fuel tank cap	
4	Main grounding wire		40	Oil level observation window	
5	Hexagonal flange face bolt	M6×12	41	Shock absorption and buffering rubber	
6	Square nut	M6	42	Hexagonal flange face bolt	M5×8
7	Hexagonal head shoulder bolt	M6×18	43	Oil level pressure plate	
8	Hexagon nut	M5	44	Oil level component	
9	Hexagonal flange surface nut	M6	45	Fuel filter	
10	Frame shock absorber pad		46	Pipe clamp	φ 11
11	Hexagonal flange surface bolt	M6×18	47	Fuel-oil pipe (single piece)	φ 6.0× φ 10.0
12	Base plate		48	Pipe clamp	
13	Rack shock absorber base		49	Handle	
14	Air filter housing		50	Cover plate	
15	Filter element support plate		51	Handle guard block	
16	Air filter filter element		52	Cover plate decorative ring	
17	Air filter housing cover		53	DC module	
18	Cross-slot hex head screw	M6×20	54	Hexagonal flange face bolt	M6×16
19	Shock absorption buffer rubber		55	Box body air guide plate	
20	Handle		56	Inverter	
21	Cross-slot cap screw	M5×16	57	Oil switch assembly	
22	Cover plate		58	Panel rear cover housing	
23	Semi-circular head self-tapping screws	KAL50×12	59	Cross-slot pan-head self-tapping screws	ST4×12
24	Oil observation window latch		60	Control panel assembly	
25	Cover plate		61	Hexagonal flange face bolts - enlarged series	M5×12
26	Oil observation window knob		62	Oil switch handle	
27	Grooved head that does not come off the screw	M6×12	63	Cross-slot pan head screws, flat washers and spring washers assembly	M4×12
28	Spark plug maintenance cover		64	Parallel socket assembly	
29	Spark plug cover anti-detachment chain		65	Digital voltmeter	
30	Muffler tail cover		66	Indicator light	
31	Muffler heat insulation rubber strip		67	Grounding module	
32	Internal serrated locking gasket	φ 5×14×0.5	68	Reset button	
33	Shock-absorbing rubber pad of the fuel tank		69	Switch	
34	Fuel tank body		70	USB	
35	Fuel filter screen		71	Europe socket	
36	Cover plate		72	Grounding bolt	

PG3500Ci-EX-CK03P2026036T

ENGINE FOR PG3500Ci

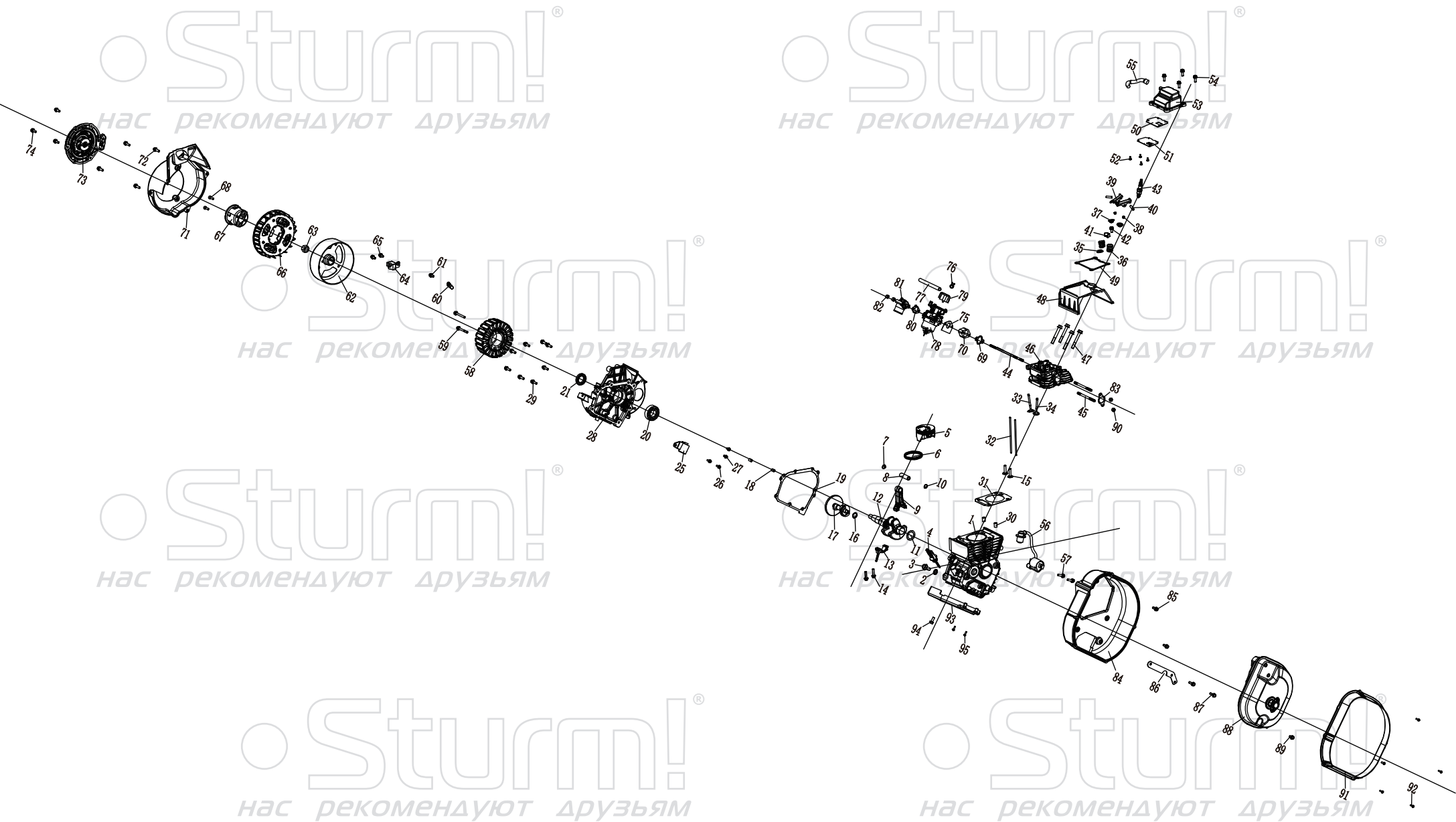

ENGINE FOR PG3500Ci

NO.	DESCRIPTION	SPEC.	NO.	DESCRIPTION	SPEC.
1	crankcase		50	Cylinder head cover inner cover gasket	
2	Oil drain bolt gasket		51	Cylinder head respirator	
3	Oil drain bolt	M10 x 1.25 x 15	52	Cross recessed pan head screw, flat washer, and spring washer	M4x8
4	Oil level gauge		53	Cylinder head cover assembly	
5	piston		54	Hexagon flange bolts	M6x18
6	Piston ring combination		55	Exhaust pipe	
7	Piston pin clamp ring		56	Ignition coil	
8	Piston pin		57	Hexagon flange bolts	M6x18
9	Connecting rod body		58	Magneto stator assembly	
10	Piston pin clamp ring		59	Stator bolts	M6x50
11	Flat washer	Φ25 x Φ36 x 0.5	60	Cable ramp	
12	Crankshaft component		61	Hexagon flange bolts	M6x12
13	Connecting rod end cap		62	Magneto rotor assembly	
14	Connecting rod bolt		63	Flywheel nut	M14 x 1.5
15	Valve tappet		64	flip-flop	
16	Flat washer	Φ18 x Φ10 x 0.5	65	Hexagon flange bolts	M6x12
17	Camshaft components		66	impeller	
18	Locating pin		67	Starting cup	
19	Crankcase gasket		68	Hexagon bolt	M6x16
20	Deep groove ball bearing		69	Air intake gasket	
21	Oil seal		70	Carburetor heat shield	
25	Oil sensor		71	Wind deflector	
26	Hexagon Flange bolts - Large series	M5x12	72	Hexagon flange bolts	M6x18
27	Hexagon flange bolt	M5x8	73	pull-plate	
28	Crankcase cover		74	Hexagon flange bolts	M6x16
29	Hexagon flange bolts	M6x22	75	Carburetor gasket	
30	Locating pin		76	Tubing clamp	
31	Cylinder head gasket		77	Oil pipe	
32	The valve tappet		78	Carburetor components	
33	Inlet valve		79	Stepper motor	
34	Exhaust valve		80	Air filter gasket	
35	Oil shield		81	Air filter housing	
36	Valve spring		82	Hexagon flange nut	M6
37	Intake valve spring seat		83	Exhaust port gasket	
38	Air lock clamp		84	Muffler inner cover	
39	Valve rocker arm		85	Hexagon flange bolts	M6x16
40	Valve rocker arm shaft		86	Muffler retaining block	
41	Rocker arm shaft baffle		87	Hexagon flange bolts	M6x22
42	Hexagon flange bolts	M6x12	88	Muffler component	
43	Spark plug		89	Hexagon flange bolts - Large series	M6x12
44	Double stud	M6x120	90	Hexagon flange nut	M6
45	Double stud	M6x96	91	Muffler enclosure	
46	Cylinder head		92	Cross recessed pan head tapping screw	M4x12
47	Cylinder head bolt	M8x60	93	Housing air deflector	
48	Cylinder head air hood		94	Hexagon flange bolts	M6x16
49	Cylinder head cover gasket		95	Semi-round head tapping screw	M5x12